

QS-220

User Manual
R2 and Older

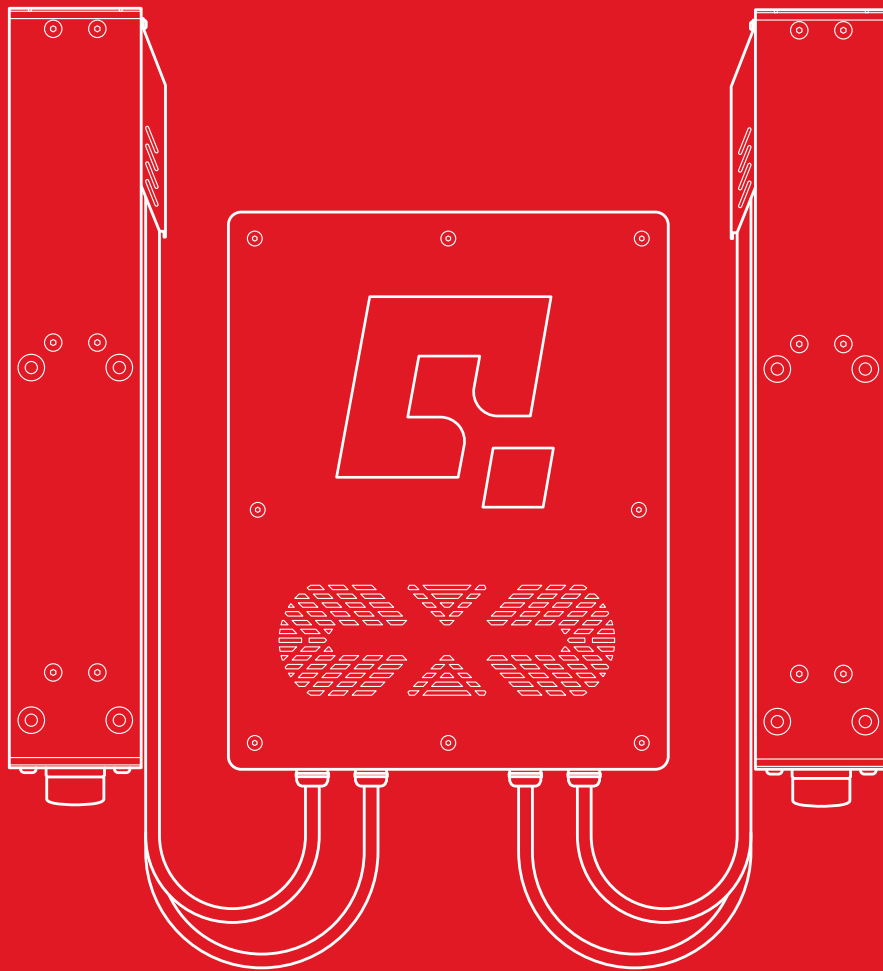

QUBICSYSTEM

The Motion Systems, manufacturer of Qubic System, would like to thank you for choosing the QS-220-PL , an innovative product that helps you develop highly reliable training and entertainment solutions that reproduce key immersive elements, such as surface textures, acceleration, engine vibrations and vehicle dynamics for multiple types of land, air or sea vehicles. Our motion system has been designed to deliver the most realistic simulation experience. We hope you enjoy your new Qubic System!

Join our sim racing channel at the Qubic System YouTube

<https://www.youtube.com/c/QubicSystem>



NEWS & EVENTS

The latest news from the simulation world.
QubicSystem.com/News



CHECK OUR SOCIAL MEDIA

Everything you wish to know is here!
facebook.com/qubicsystem



SUPPORTED GAMES

Racing games and professional simulation software.
QubicSystem.com/Supported-Games

Contents

1	Important Safety Instructions	5
1.1	Essential Information	5
1.2	Health and Safety Instruction	7
2	Product description	10
2.1	Intro Set	11
2.2	Extension set	13
2.3	Dimensions	14
2.4	Voltage system	15
2.5	Grounding requirements	15
2.6	Power requirements	16
3	Setup and installation	17
3.1	Before QS-220-PL Installation	17
3.2	Intro Set: QS-SB2 connection - 2 Actuators	19
3.3	Extended Set: QS-SB2 connection - 4 Actuators	20
3.4	Extended Set: connection with traction loss system	21
3.5	Intro Set: layout setup	22
3.6	Extended Set: layout setup	23
3.7	QS-220-PL Assembly Instruction	26
3.8	Software Installation	27
4	Maintenance and Cleaning	35
5	Troubleshooting	35
6	Advanced applications	36
6.1	Adding additional devices to the motion lock circuit	36
6.2	Implementing the working zone protection	38
6.3	Increasing safety level	39
6.3.1	Assembling Motion Lock jumpers	39
6.3.2	Adding power-cut circuit with E-STOP button	41
6.3.3	Implementing the working zone protection with power-cut circuit	43
7	Conformity Information	44
8	Environmental Impact and Disposal	44
9	Liability Disclaimer	44
10	Warranty	45
11	Copyright	46
12	Manufacturer information	46

1. IMPORTANT SAFETY INSTRUCTIONS

INFO

Read all safety instructions before installing and using this product. Save this document for future reference. If ownership of this product is transferred, be sure to include this manual.

WARNING

QS-220-PL is not intended for use by children under 16 years of age. Close supervision and safety instruction is required when this product is used by or near children or people with reduced physical, sensory or mental capabilities. Keep the packaging away from small children as it poses a suffocation risk.

1.1. ESSENTIAL INFORMATION

To reduce the risk of burns, fire, electrical shock, injury or mechanical damage:

- Use the QS-220-PL only for its intended purpose, according to instructions.

WARNING



Always turn all the power switches off before plugging and unplugging the QS-220-PL . Dangerous voltages level can be present in Power Cabinet for a few minutes after turning off the machine.

- Unplug the QS-220-PL from the power source if it is not used for an extended period or when there is a need to perform hardware installation, maintenance, servicing or repairs.
- Turn the QS-220-PL off when it is not in use.
- The QS-220-PL was designed for indoor use only - **DO NOT** store or use the product outdoors.
- Keep the QS-220-PL away from the heat sources, high humidity, water, and other liquids. **DO NOT** store in cold place where condensation may occur.
- **DO NOT** disassemble the product. Any tampering with or altering the product will void the warranty, poses a serious risk of electric shock, and may irreparably damage the product.

- **DO NOT** cover the vents.
- Keep the power cord plug and the socket dry, clean and dust-free.
- Protect the power cord from damage caused by being stepped on, rubbed against, or pinched.
- **DO NOT** use the QS-220-PL if the ambient temperature is below 4° Celsius (39° Fahrenheit) or above 45° Celsius (113° Fahrenheit).
- **DO NOT** use the QS-220-PL if it has been damaged, or any component is broken or missing. Please contact technical support.
- **DO NOT** use attachments or replacement parts not recommended or approved by the manufacturer. **DO NOT** replace the power cables provided with the product. Use certified power and USB cables only.
- Connect the QS-220-PL to a properly grounded outlet only. See grounding instructions in section 2.5 on page 15.
- If you want to increase safety level of the system, you can add external safety devices. For detailed information check section 6 on page 36.

WARNING

Stop using the QS-220-PL immediately and contact technical support when the machine starts to emit unusual noise, smoke or any other suspicious behaviour indicating the machine is not working properly.

INFO

The maximum supported length of cables is 3 meters:

- the maximum supported length of the USB cable is 3 meters
- the maximum supported length of the M-BUS cable between M10 and QS-SB2 is 3 meters
- the maximum supported length of the M-BUS cable between the QS-SB2 is 3 meters
- the maximum supported length of the MotionLock cable is 3 meters

1.2. HEALTH AND SAFETY INSTRUCTION

The safety of Qubic System users is the top priority. To protect users and bystanders against injuries caused by mechanical parts movement and electrical connectivity, the following instructions must be strictly performed.

WARNING

As with any mechanical device, the user is responsible for inspecting the condition of the machine prior to use and adhering to safe operating procedures.

What must be done before turning on the machine:

- Check if nothing is blocking machine movements or air vents. The minimum distance between the air vents in the power cabinets and any outside parts of the cockpit equipment is 10 cm or 4 in.

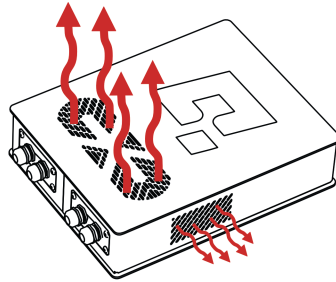

- Check if cables are mounted properly – they are not stretched or loosely connected to the socket and placed out of the moving range of the system components.
- Check that all elements are properly fixed.
- Check if there are no sharp edges nearby.

WARNING



Dangerous voltage level may occur in Power Cabinet and cables during the operation and for a few minutes after turning off the machine.

How to turn on and use the QS-220-PL safely:

- Check if everyone around is aware of machine rapid movements.
- Make sure that no one stands in the range of motion (minimum 1.5 m).
- Kids should be kept away from the machine.
- Pets should be kept away from the machine.
- When the QS-220-PL is turned on, it performs start-up calibration.

WARNING

QS-220-PL will move automatically after turning it on in order to perform start up procedure. Please be away of that movement and do not try to interrupt it.

- **DO NOT** interrupt or change the weight of payload mounted to the QS-220-PL during start-up calibration.
- Motion Lock Switch should be mounted close to the operator of the machine – it has to be easily reachable in every situation.
- Check Motion Lock Switch **AT LEAST** once a month to reduce the possibility of unknown failure – more information available in chapter 4 on page 35.
- Before getting on or off the machine, make sure to push the Motion Lock Switch.

It is also possible to check if the machine is in the Motion Lock mode in software – QubicManager – it is visible in the lower left corner of the QubicManager as "Connected - Offline/Safety Stop". More information about software in section 3.8 on page 27.

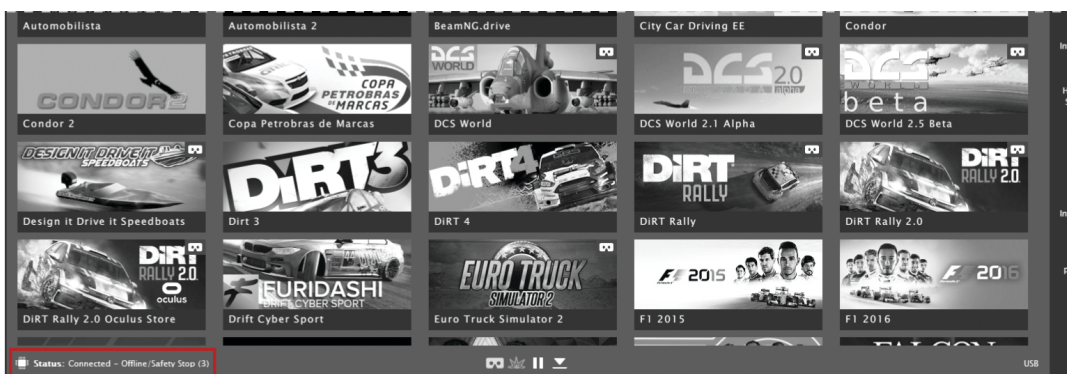

- In case of game crash, the Motion Lock Switch must be pressed before getting off the machine.

WARNING

Motion Lock and Park Mode option **DOES NOT** guarantee safety. For more details see section 6.

- For VR Headset users:
 - Remove the VR goggles before entering or exiting the rig.
 - Check very carefully if cables from VR Headset are not limiting the operation range of QS-220-PL .
 - Check if the whole VR setup is not in range of motion of the machine.
 - Check if cables are protected from being crushed by the QS-220-PL – **DO NOT** place them loosely under the motion rig.

INFO

Check if connected PC is capable of running the game at stable 90 frames per second or more when VR Headset is used. Lower values can cause VR sickness.

- **DO NOT** use QS-220-PL if you are pregnant, tired, or under the influence of alcohol or drugs.
- **STOP USING** the QS-220-PL immediately if pain, fatigue or any discomfort appears.
- For every two hours of playing, we recommend at least **15 MINUTES OF BREAK**.
- **DO NOT** put your hands or legs in the actuators range of motion!
- **DO NOT** use the QS-220-PL around small children or pets.
- **DO NOT** put any items between actuators and stabilization plates.
- **DO NOT** pull the wires connecting the actuators with the power cabinets.



2. PRODUCT DESCRIPTION

QS-220-PL is designed with upgradability in mind – it is possible to expand 2DOF Setup later on. Available variants are presented below.

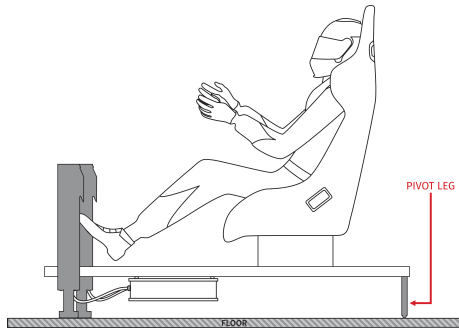

Intro set - 2DOF - Front variant

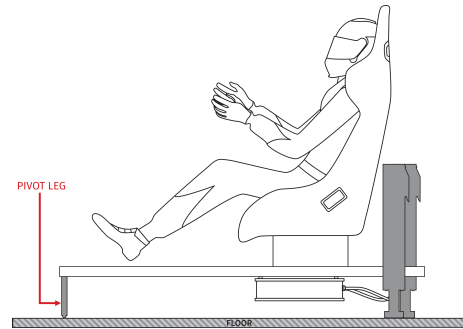

Intro set - 2DOF - Back variant

WARNING

QS-220-PL is delivered without the pivot leg.

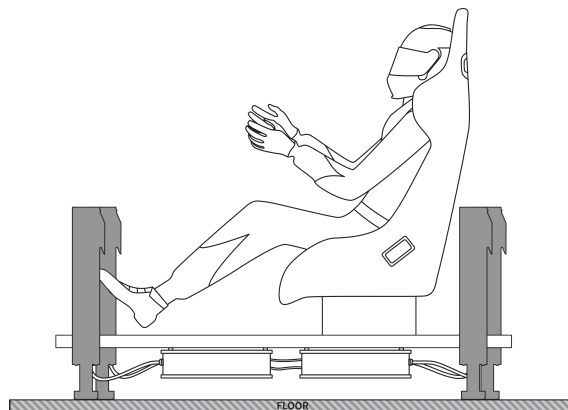

Extended set - 3DoF

2.1. INTRO SET

WARNING

Check if the package contains all listed parts. If it is incomplete, please contact the distributor/reseller.

For beginners, two actuators variant can be sufficient, Motion Systems provides the option to buy Intro Set that contains QS-MC6 and QS-220-PL (**QS-220-PL is delivered without the pivot leg**).

The QS-MC6 includes following components :

- Motion lock switch (x 1)
- Micro USB cable (x 1)
- BUS communication cable (x 1)
- M10 controller (x 1)
- QS-MBT-1 BUS terminator (x 1)
- Motion lock adapter (x 1)

M10 controller is specifically designed to use communication protocol created by Motion Systems. It allows connecting PC with the QS-220-PL , **DO NOT** try to substitute this device. M10 requires USB 2.0 or higher (for both cable and port in PC). QS-MBT-1, will be referred as "BUS Terminator", which is an RJ45 connector with the resistor. It is a small but very important part used to mark the last Power Cabinet in the set.

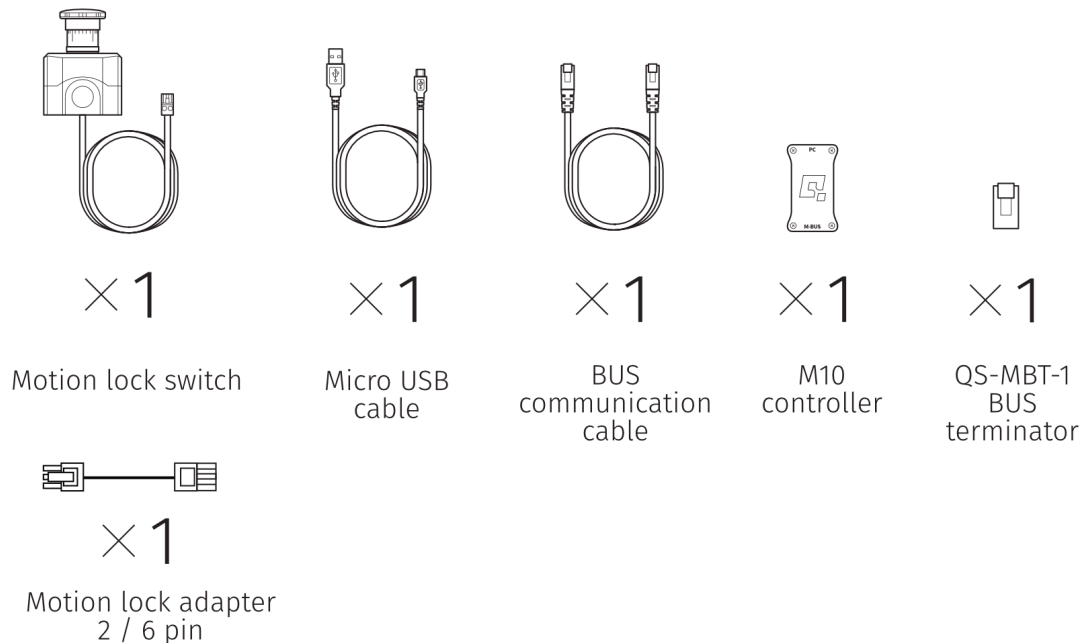

The QS-220-PL includes following components:

- QS-L1 actuator (x 2)
- QS-SB2 power cabinet (x 1)
- Power cord (x 1)
- BUS communication cable (x 1)
- Motion lock adapter (x 1)
- Motion link interlink cable (x 1)
- Stabilization plate (x 2)
- M8x20 bolts (x 16)
- M6x12 bolts (x 8)

QS-220-PL is a set composed of 2 Actuators (QS-L1) and Power Cabinet (QS-SB2). It can be used to set up various motion rigs (more information about motion rigs in section 3.7 on page 26).

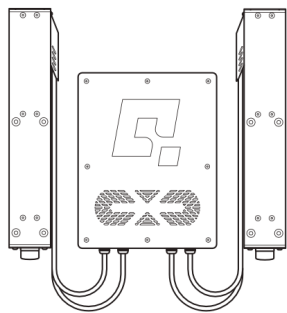

× 1

QS-L1 actuators
QS-SB2 power cabinet

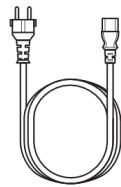

× 1

Power cord



× 1

BUS
communication
cable



× 1

Motion Lock
interlink cable



× 2

Stabilization
plate



× 16

M8 x 20



× 8

M6 x 12

2.2. EXTENSION SET

INFO

If you own Intro Set and want to expand your rig and experience by adding a second QS-220-PL please contact the distributor/reseller for more information.

For more demanding applications or customers who want to improve their experience even further, we created an Extension Set. It is designed to be connected with Intro Set - this set does not include QS-MC6 with M10 connector as there is no need to have 2 of them in motion rig - communication between Power Cabinets is done by connecting them directly to each other. Intro Set (QS-220-PL) connected with Extended Set results in 3DoF configuration.

The Extension set includes following components:

- QS-L1 actuator (x 2)
- QS-SB2 power cabinet (x 1)
- Power cord (x 1)
- BUS communication cable (x 1)
- Motion link interlink cable (x 1)
- Stabilization plate (x 2)
- M8x20 bolts (x 16)
- M6x12 bolts (x 8)
- Motion lock adapter (x 1)

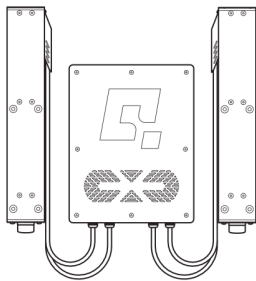

× 1

QS-L1 actuators
QS-SB2 power cabinet

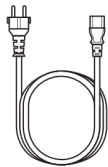

× 1

Power cord



× 1

BUS
communication
cable



× 1

Motion Lock
interlink cable



× 2

Stabilization
plate



× 16

M8 x 20



× 8

M6 x 12

For more information about setup with 4 actuators, check section 3.7 on page 26.

2.3. DIMENSIONS

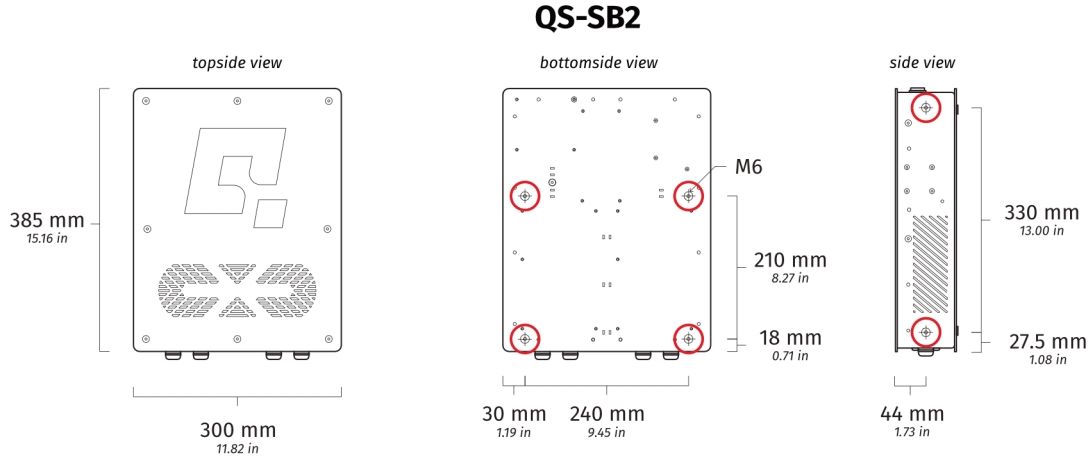

QS-SB2

frontside view

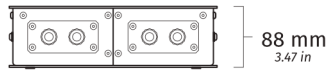

QS-L1

side view

top + side view

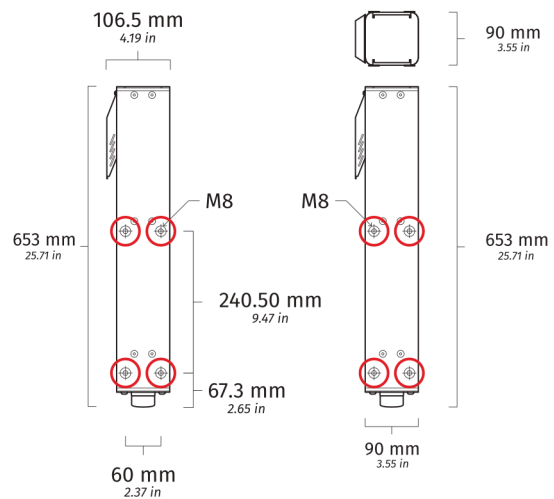

MOTION LOCK ADAPTER

topside view

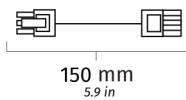

MOTION LOCK

front view

bottom view

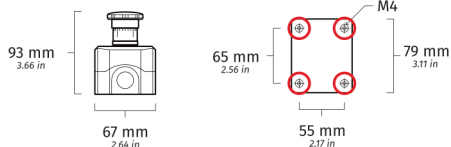

M10

front view

side view

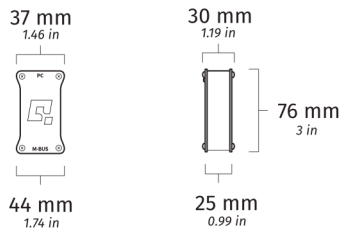

STABILIZATION PLATE

side view

top view



2.4. VOLTAGE SYSTEM

QS-220-PL requires 120/230 VAC single phase with ground and neutral connection.

2.5. GROUNDING REQUIREMENTS

INFO

Use only a high-quality power plug adapter purchased from trusted suppliers.

In case of a system malfunction or breakdown, grounding provides a path of the least resistance for electric current to reduce the risk of electric shock. If the place (where the QS-220-PL is mounted) can not provide proper grounding, according to the description, please contact a qualified electrician for help.

The QS-220-PL is equipped with an electric cord having an equipment-grounding conductor, and a grounding plug. The plug must be plugged into a matching outlet that is properly installed, and grounded in accordance with all local codes and ordinances. It is recommended to use multiple, separately fused wall sockets.

DO NOT modify the plug provided - if it will not fit the outlet, contact adequate technical support.

Applicable plugs for different regions:

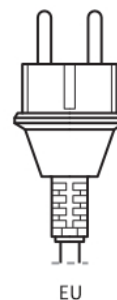
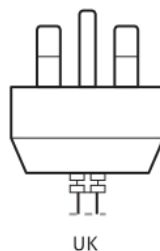

2.6. POWER REQUIREMENTS

Power Cabinet (QS-SB2) contains the power supply for connected actuators. If there is no certainty if fuses or entire electrical installation can handle QS-220-PL , contact a qualified electrician. Be aware that with heavy payload, and/or more intense simulations average power consumption may rise.

WARNING

For safety reasons, **DO NOT** attempt to modify machines or cables by yourself. QS-220-PL can be used in 120V AC/230V AC, 50~60Hz environment. Remember to use adequate cables with proper grounding in each case!

WARNING

Always **UNWIND THE CABLE COMPLETELY** when using a cable reel and untangle an extension cord before connecting the device to the power supply.

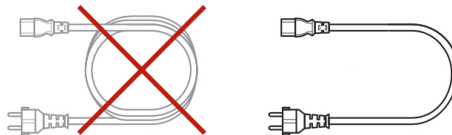

WARNING

Check if the power cord plug has grounding connection (with 3 pins). In order to reduce risk of electric shock **DO NOT** use plug without grounding connection (without center pin).

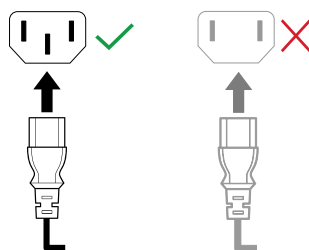

INFO

If motion rigs with two Power Cabinets (4 Actuators Setup) are connected to 120V then each Power Cabinet should be connected to the different wall socket with separate fusing - it might be required, to ensure trouble-free work of the QS-220-PL . The grounding point shall be common.

3. SETUP AND INSTALLATION

3.1. BEFORE QS-220-PL INSTALLATION

Qubic System **DOES NOT** approve exceeding or ignoring any of the points below and **IS NOT** responsible for malfunctions, failures or injuries that are results of these actions :

WARNING



Dangerous voltage level may occur in the QS-SB2 power cabinet and connected cables during the operation and for a few minutes after turning off the machine. Do not touch the device when the power switch is on.

WARNING

DO NOT LIFT BY THE CABLE

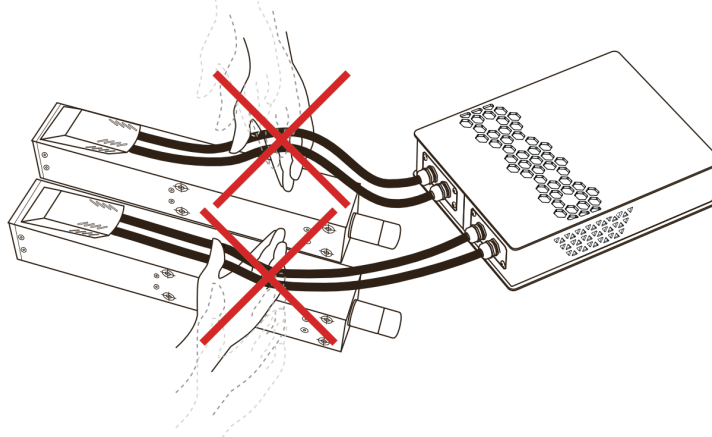

- Cables must not be stretched and should be kept in a way that prevents them from getting under the actuator or any part that can crush or tear them.
- **DO NOT** place down the actuators on the cable side on any surface, always place them down with cable side up to avoid cable damages.

WARNING

- Each Actuator has to be used with the Stabilization Plate and should be placed on a flat surface.
- **DO NOT** use the actuators on very soft or fragile surfaces like rubber, glass, or foam.
- Be aware that QS-220-PL will crawl a little in every direction during operation. Those movements could damage the surface in the long term. The manufacturer, its subsidiaries and their partners, are not responsible for any floor damages.
- **DO NOT** mount the rig in tight or cluttered spaces – remember that actuators set motions to the rig and nothing should restrict its motion range.
- Seat belts and other harnesses should be mounted as part of the motion rig that move in the same way as the seat. **DO NOT** attach them to any static part or ground.
- If you want to use the QS-220-PL in an unusual application, and you are not sure, that the desired setup is feasible, contact the distributor/reseller.

3.2. INTRO SET: QS-SB2 CONNECTION - 2 ACTUATORS

To connect QS-220-PL apply following steps:

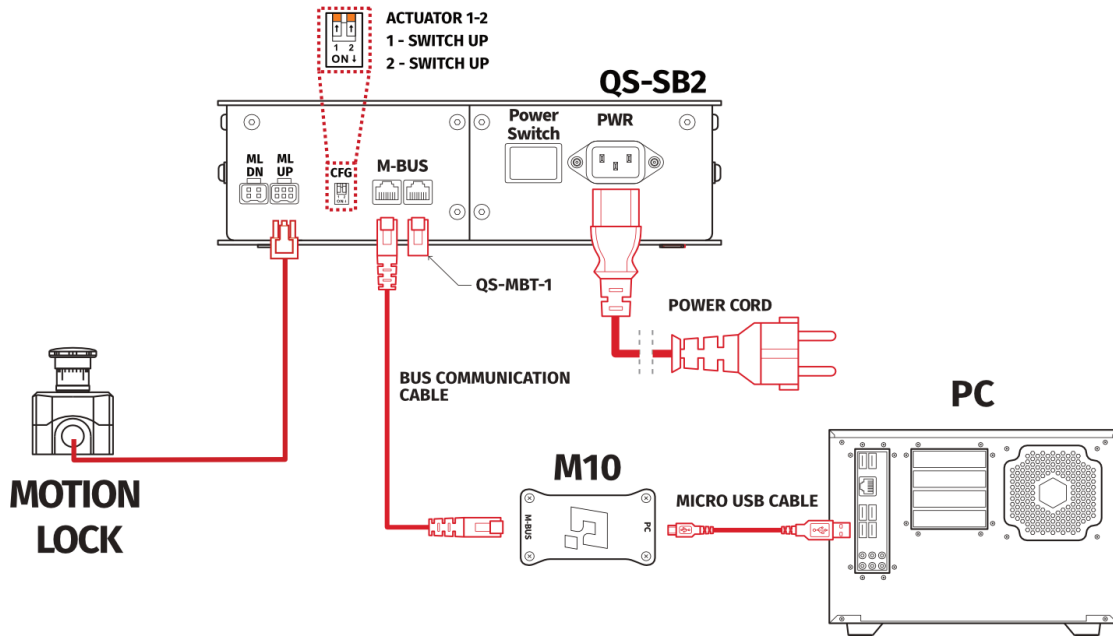

1. Plug in the Motion Lock with Motion Lock adapter into Motion Lock "ML UP" port in the QS-SB2 Power Cabinet.
2. Connect M10 to M-BUS port in Power Cabinet using BUS communication cable at both ends.
3. Put QS-MBT-1 BUS terminator (RJ45 plug with resistor) in second M-BUS port in the QS-SB2 Power Cabinet.
4. Connect PC to the M10 controller using USB – micro USB cable (2.0 or newer)
5. Plug in the power cable with adequate type of plug into power socket in the QS-SB2 Power Cabinet.

INFO

Order of connecting the cables is not important, keep the CFG switches according to appropriate layout.

3.3. EXTENDED SET: QS-SB2 CONNECTION - 4 ACTUATORS

In rigs with 4 actuators, both Power Cabinets have to be connected to each other, connect them by applying following steps:

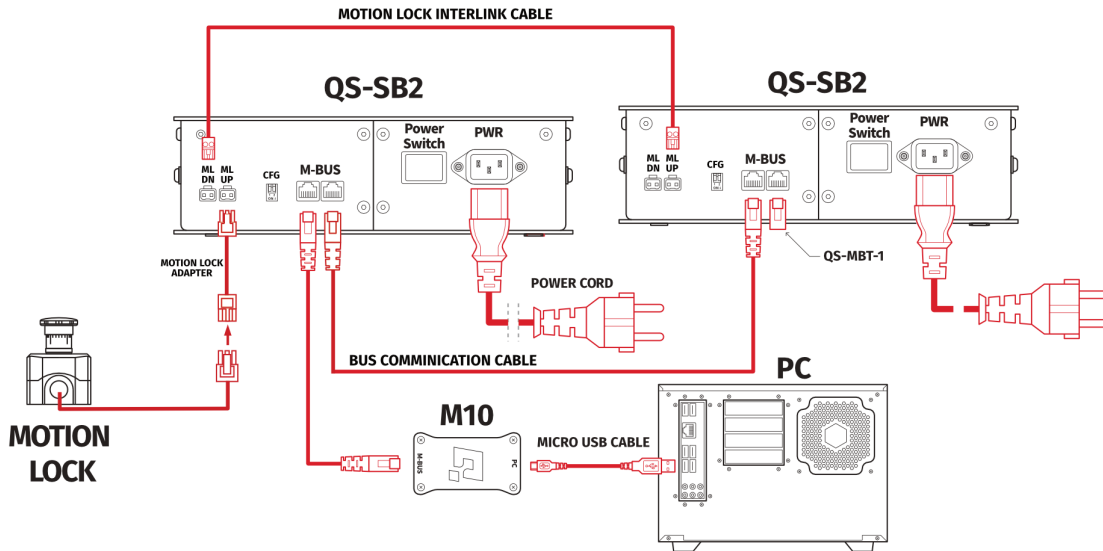

1. Plug in the Motion Lock with Motion Lock adapter into Motion Lock "ML UP" port in the QS-SB2 Power Cabinet.
2. Connect Motion Lock "ML DN" port from the first QS-SB2 to Motion Lock "ML UP" port in the second QS-SB2 power cabinet using motion lock interlink cable.
3. Connect M-BUS ports in both power cabinets using BUS communication cable.
4. Put BUS terminator (QS-MBT-1) in the last M-BUS port in second Power Cabinet.
5. Connect M10 to M-BUS port in the QS-SB2 power cabinet.
6. Connect PC to the QS-220-PL using USB – micro USB cable (2.0 or newer) and M10 connector.
7. In both power cabinets, plug in the power cables with adequate plugs into power sockets.
8. Set the appropriate position on the CFG Switch according to the actuators layout of your choice (more information about CFG Switch position and layout selection in section 3.6 on page 23).

INFO

Order of connecting the cables is not important, you can connect the M10 controller or Motion Lock to either of the QS-SB2 power cabinet. Keep the CFG switches according to appropriate layout.

3.4. EXTENDED SET: CONNECTION WITH TRACTION LOSS SYSTEM

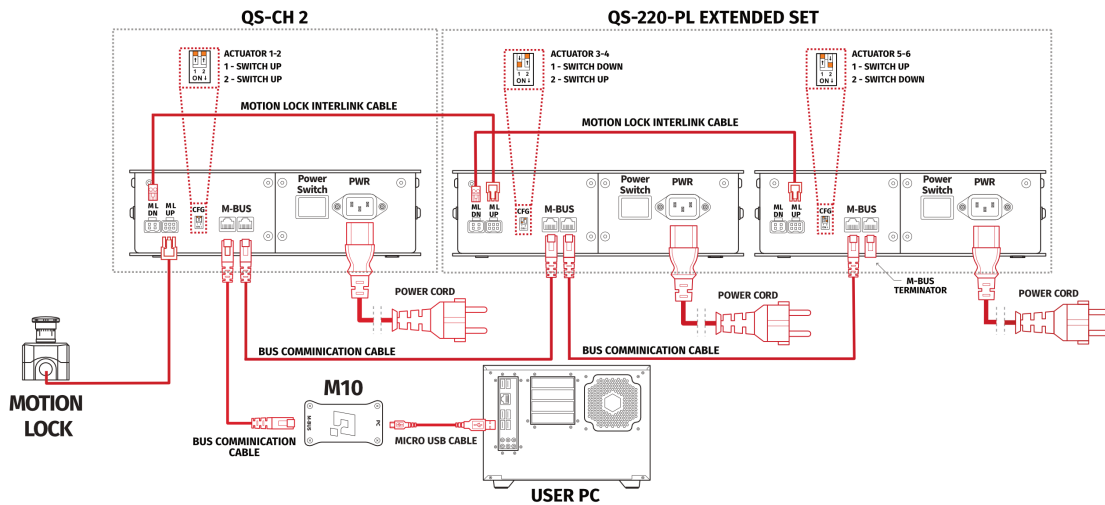

1. Plug in the Motion Lock Switch into the "ML UP" port in the first QS-SB2 power cabinet.
2. Connect Motion Lock "ML DN" port in the first power cabinet to Motion Lock "ML UP" port in the second power cabinet using motion lock interlink cable.
3. Connect Motion Lock "ML DN" port in the second power cabinet to Motion Lock "ML UP" port in the third power cabinet using motion lock interlink cable.
4. Connect M-BUS ports in all power cabinets using BUS communication cable.
5. Put QS-MBT-1 terminator in the last M-BUS port in the third QS-SB2 power cabinet.
6. Connect M10 to the first M-BUS port in first QS-SB2 power cabinet.
7. Connect PC to the M10 controller using USB cable.
8. In all power cabinets, plug in the power cables with adequate plugs into power sockets.
9. Set the appropriate position on the cable the CFG Switch as shown on the connection scheme.

INFO

Order of connecting the cables is not important, you can connect the M10 controller or Motion Lock Switch to either of the QS-SB2 power cabinet. Keep the CFG switches according to appropriate layout. Check section 3.5 and 3.6 for layout setup.

3.5. INTRO SET: LAYOUT SETUP

For the Intro Set (2DOF) layout setup must be done using QubicManager Software - Hardware Configuration panel (check item **10.** on page 29).

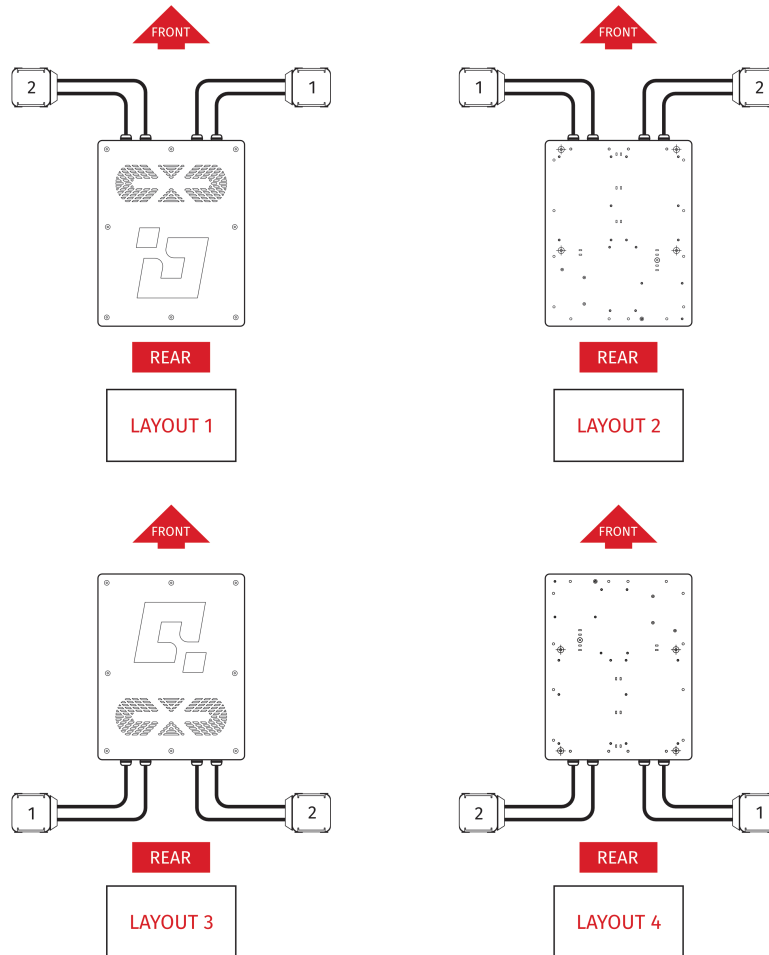

3.6. EXTENDED SET: LAYOUT SETUP

Start the configuration by setting the CFG Switches to the appropriate positions in accordance with one of the eight variants of the power cabinets and actuators installation to the cockpit. Go to **QubicManager** → **Tools and Diagnostics** → **Devices** and select **Configure** (check point **14.** on page 30).

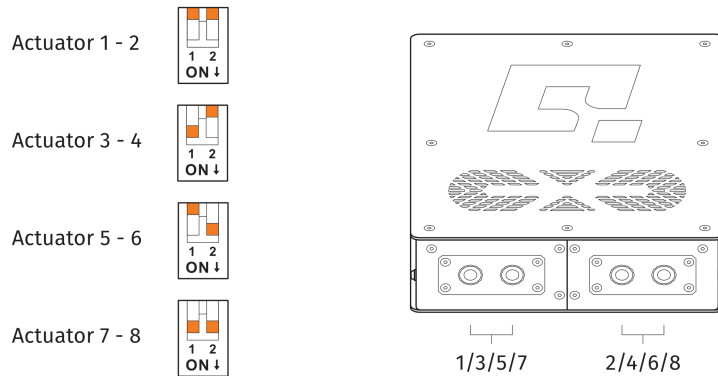

WARNING

The CFG Switch **CAN NOT** be set in the same position in both power cabinets.

WARNING

When changing CFG Switch setting the main power must be **SWITCHED OFF**.

WARNING

When changing the CFG Switch setting **FIRMLY SET THE SWITCH** into lower or upper position. Do not leave the switch in the floating position (neither up or down position), otherwise the device will not work.

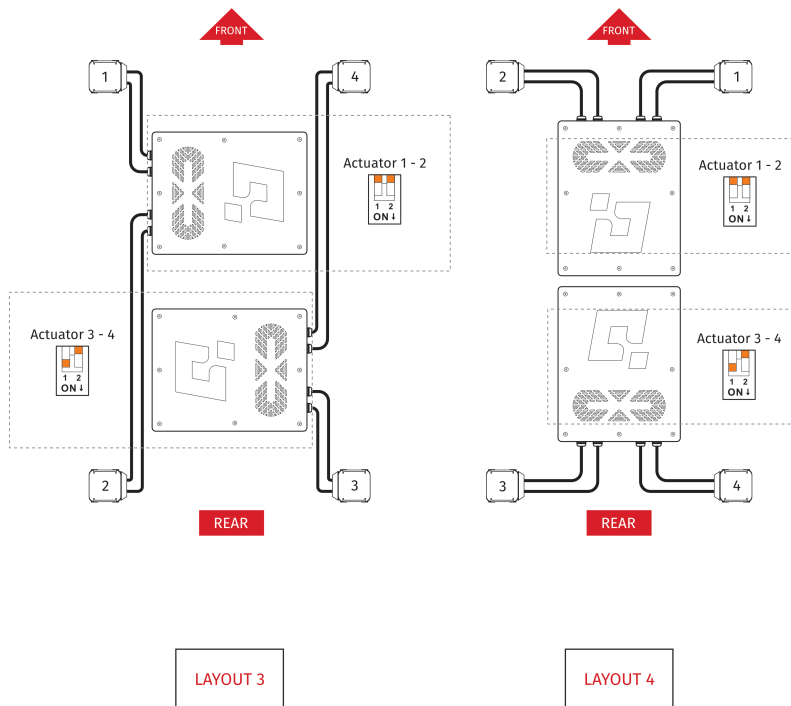
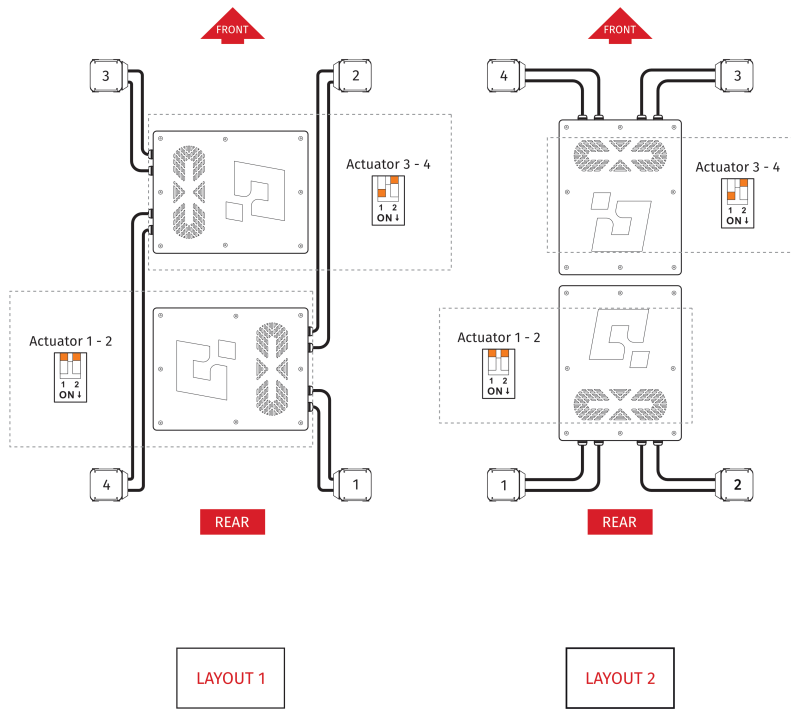

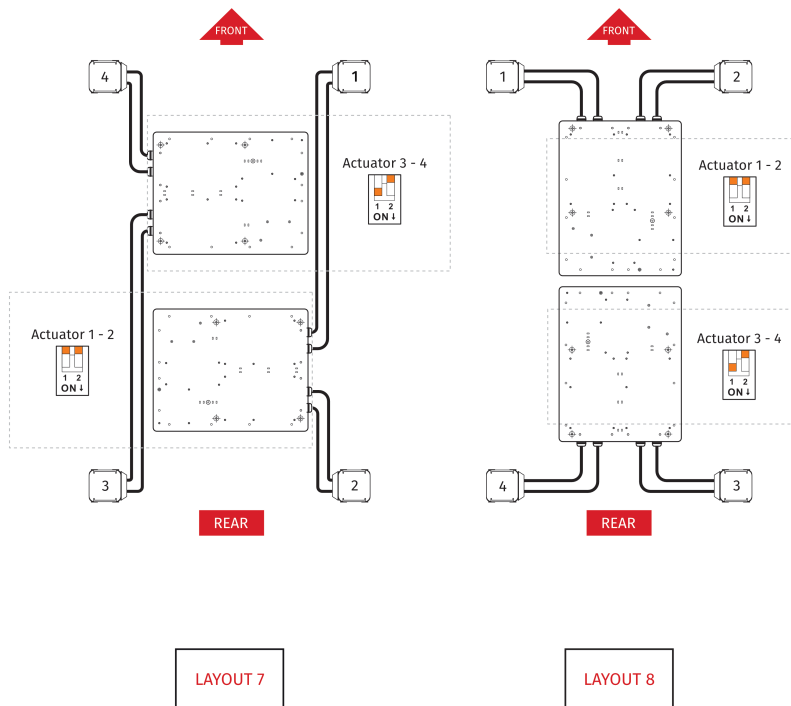
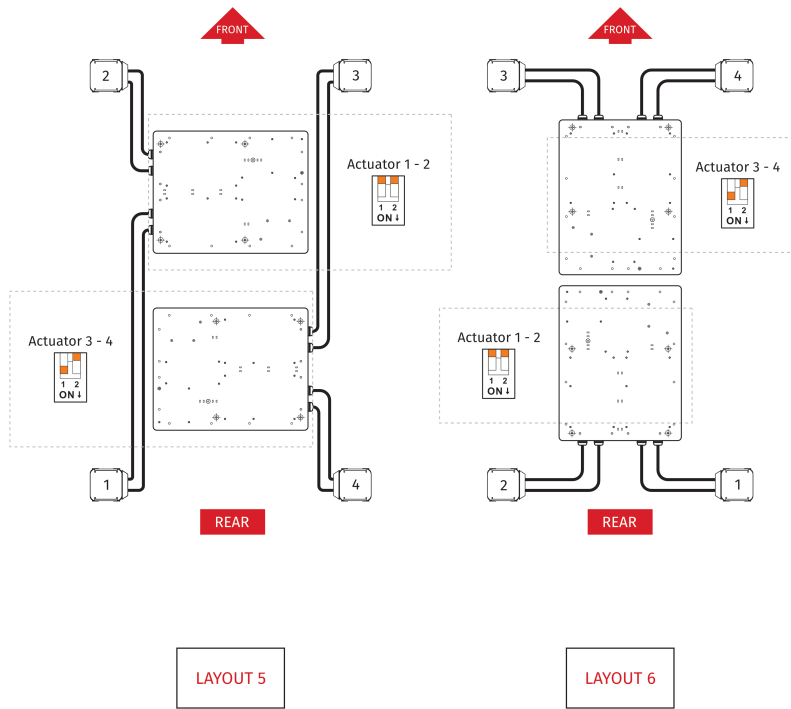

3.7. QS-220-PL ASSEMBLY INSTRUCTION

INFO

Before mounting the rig, check if the QS-220-PL is working properly. Check the positioning of the actuators and their numeration.

- Actuators should be connected to the motion rig with 8 screws (M8x20) each.
- Power Cabinet has to be mounted using at least 4 screws (M6x12) – we recommend mount it in the middle of the motion rig. It is possible to mount the power cabinets using the bottom or side mounting holes. Check section 2.3 on page 14.

WARNING

Ensure that the Power Cabinet does not have a collision with the floor in any position of motion rig.

Example of connected rig – notice that Actuators have to be perpendicular to the ground:

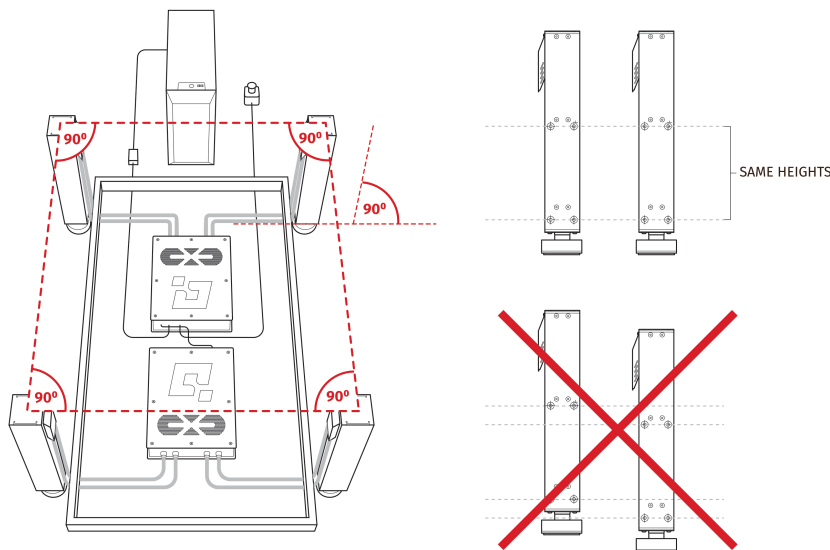

WARNING

Ensure that Actuators are mounted at the same height.

Assure that the motion rig elements does not block air vents of the QS-SB2 power cabinet. The minimum distance between the air vents in the power cabinets and the elements of the cockpit equipment is 10 cm or 4 in.

INFO

The manufacturer is not responsible for quality nor compatibility of the third-party motion rigs. We recommend using dedicated Qubic System motion cockpits such as **QS-V20** or **QS-CH1**

3.8. SOFTWARE INSTALLATION

INFO

Note down the QS-220-PL serial number before installation as it's needed to access software download page.

The **SERIAL NUMBER** can be found on the M10 identification label in the **XXXXXX-XXXXXX-XXXXXX-XXXXXX** format. This serial number is also used for activation of FSMI (Force-SeatMI) and MT (Motion Theater) licences - check information on page 34.

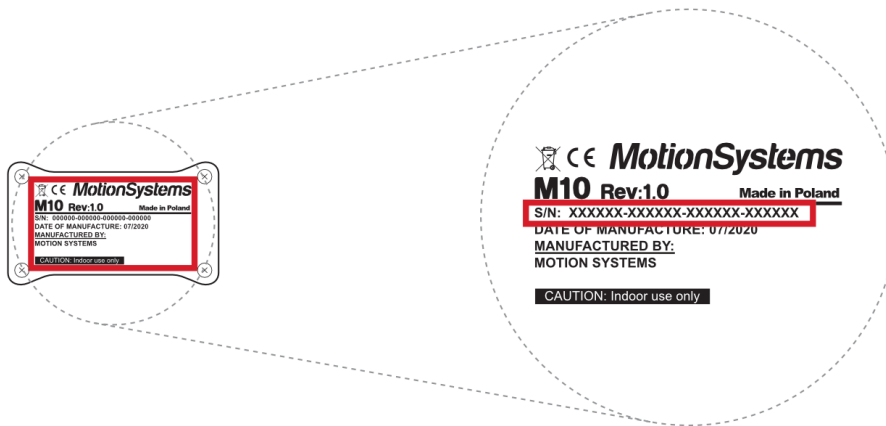

To download the software visit : QubicSystem.com/Download

Once the QS-220-PL is installed and connected correctly:

1. Connect power connection cord to the wall socket. If you own extended set connect both power cords.
2. Download QubicManager.
3. Proceed with the installation steps and launch the application.
4. Turn on the system by switching on the power switch button on the QS-SB2 power cabinet (on both if you own extended set).
5. Check position of Motion Lock Switch, unpress if needed.

- The QS-220-PL will perform a start-up calibration.

WARNING

DO NOT change the payload during the start-up calibration.

- If QubicManager has recognized the QS-220-PL correctly, the status of the machine visible in the lower left corner will change to **Connected**.
- Check **Action Center** on the right side panel for a list of actions that requires attention:

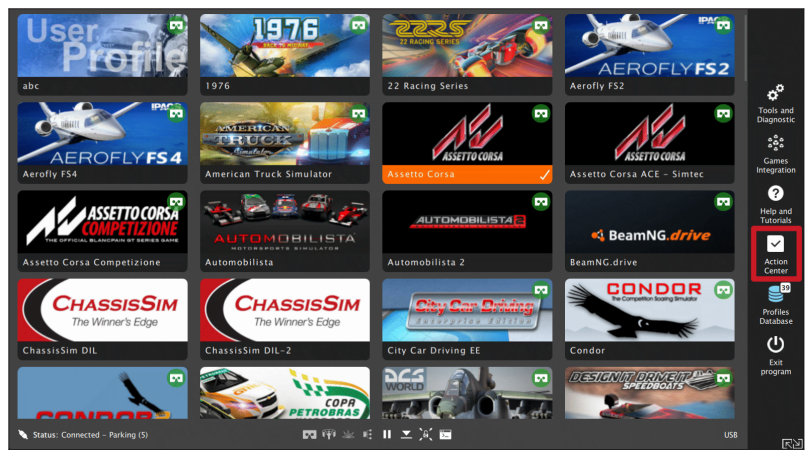

It is possible to solve them one by one or by pressing the **Resolve All** button. Firmware update may require additional confirmation in the dialogue box.

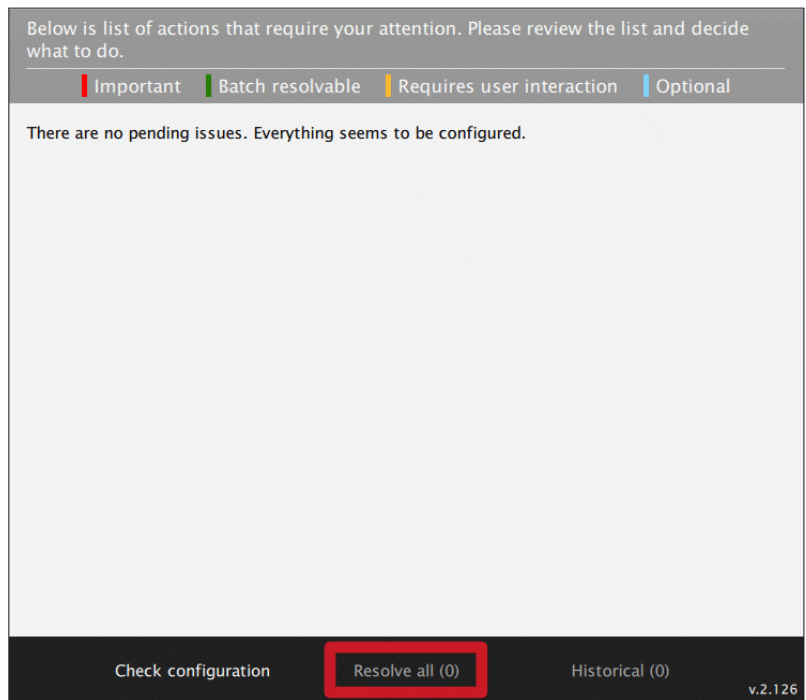

9. Go to **Tools and Diagnostics** → **Devices** and select **Configure**.

Below are all recognized devices including motion platforms and accessories.

Device #1: OS-4xx			Configure
Serial number: XXXXXX-XXXXXX-XXXX-XXXXXX	(copy to clipboard)		Levelling
Status: OK			Quick Codes
Firmware: 141.16	Temperature (C): N/A	Hardware ID: 54	
Work time: 1h 05m 17s	Up time: 0h 21m 02s	Features: default	
Paused: no	Parking: finished (normal)	Offline: no	

Device #1.1: HVFMC100		
Serial number: XXXXXX-XXXXXX-XXXX-XXXXXX	(copy to clipboard)	
Status: OK (33)		
Firmware: 144.30	Temperature (C): 24, 31	Hardware ID: 58
Work time: -	Up time: 0h 20m 29s	Features: default

Device #1.2: HVFMC100		
Serial number: XXXXXX-XXXXXX-XXXX-XXXXXX	(copy to clipboard)	
Status: OK (33)		
Firmware: 144.30	Temperature (C): 24, 31	Hardware ID: 58
Work time: -	Up time: 0h 20m 29s	Features: default

10. **FOR 2DOF CONFIGURATION (Intro set):** Choose the correct layout from the list:

Select number of actuators

Click button below to select number of actuators your system is equipped with.
Individual actuator's location will be configured on the next screen.

Next

11. Measure the distance between front side actuators. Put in the value in the platform dimensions **Width** field (in millimetres).

12. Measure the distance between front side actuators and rear pivot leg. Put in the value in the platform dimensions **Length** field (in millimetres).

Platform dimensions

Actuators geometry is based on rectangle shape. To make everything work properly you need to specify width and length of that rectangle. Only valid values guarantee that system is stable and math calculations are correct.

Width [mm]:

Length [mm]:

Stroke [mm]: 100

Layout: Layout 8

NOTE: If you are not sure what are your actuators indexes, use **Identify** action in the section below to locate them in your cockpit.

13. Scroll down in the window, you can choose one of the operation modes:

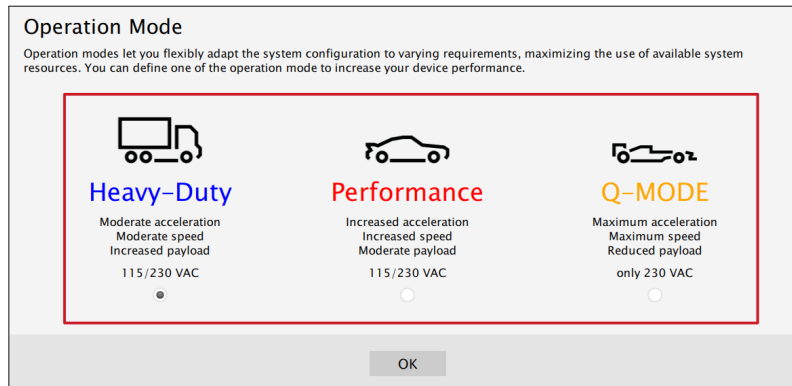

INFO
 Q-MODE is unavailable for 120V power supply.

14. FOR 3DOF CONFIGURATION (Extended set): Choose the correct layout variant from the list :

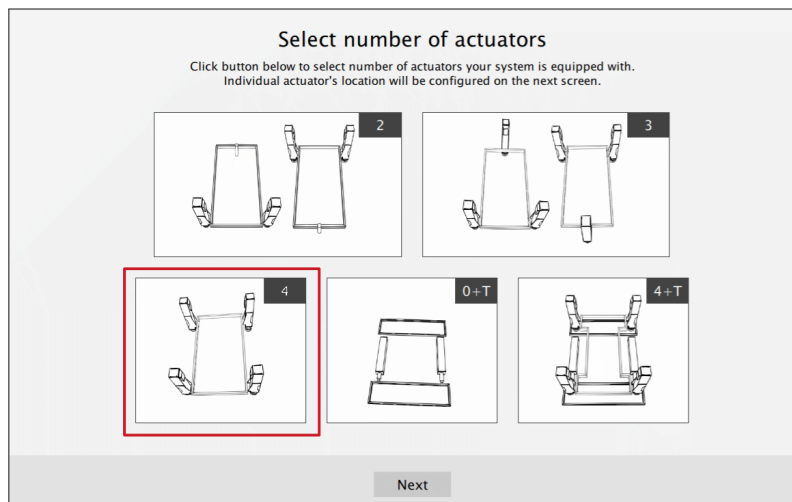

15. Measure the distance between front side actuators. Put in the value in the platform dimensions **Width** field (in millimetres).
16. Measure the distance between front and rear side actuators. Put in the value in the platform dimensions **Length** field (in millimetres).

Platform dimensions

Actuators geometry is based on rectangle shape. To make everything work properly you need to specify width and length of that rectangle. Only valid values guarantee that system is stable and math calculations are correct.

Width [mm]:

Length [mm]:

Stroke [mm]:

If the position of the actuators in the cockpit is different from that shown in the figure on the right, choose a different layout. Not all combinations are supported. If you do not find a layout that matches your settings, you will have to change the position of the actuators in the cockpit.

Layout:

NOTE: If you are not sure what are your actuators indexes, use **Identify** action in the section below to locate them in your cockpit.

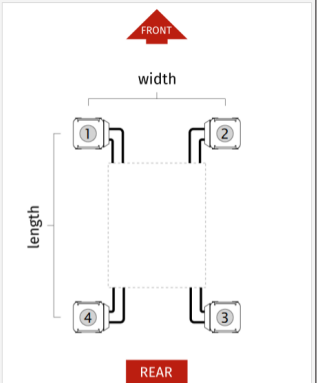

17. Scroll down in the window, you can choose one of the operation modes:

Operation Mode

Operation modes let you flexibly adapt the system configuration to varying requirements, maximizing the use of available system resources. You can define one of the operation mode to increase your device performance.



Heavy-Duty

Moderate acceleration
Moderate speed
Increased payload
115/230 VAC



Performance

Increased acceleration
Increased speed
Moderate payload
115/230 VAC



Q-MODE

Maximum acceleration
Maximum speed
Reduced payload
only 230 VAC

INFO

Q-MODE is unavailable for 120V power supply.

- Close the configuration and return to the main application window. Choose the game and check profile details by clicking on the game tile.

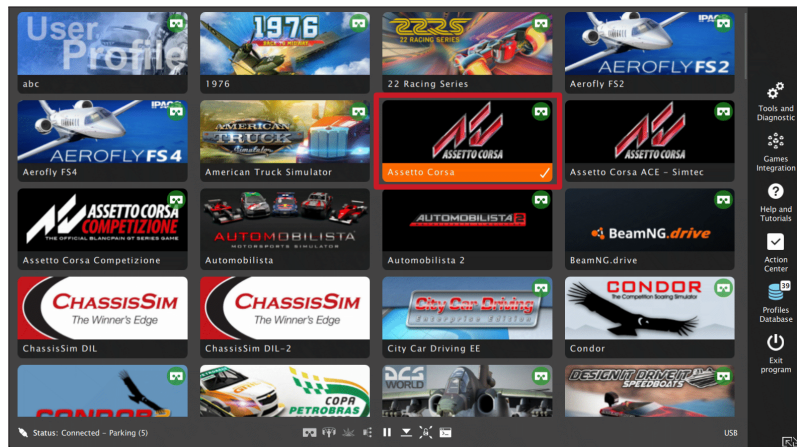

- Adjust the motion effects intensity to your preferences in the game profile window, scroll down in the window to see all of the settings. You can adjust the settings during the game simulation by pressing **ALT+TAB**.

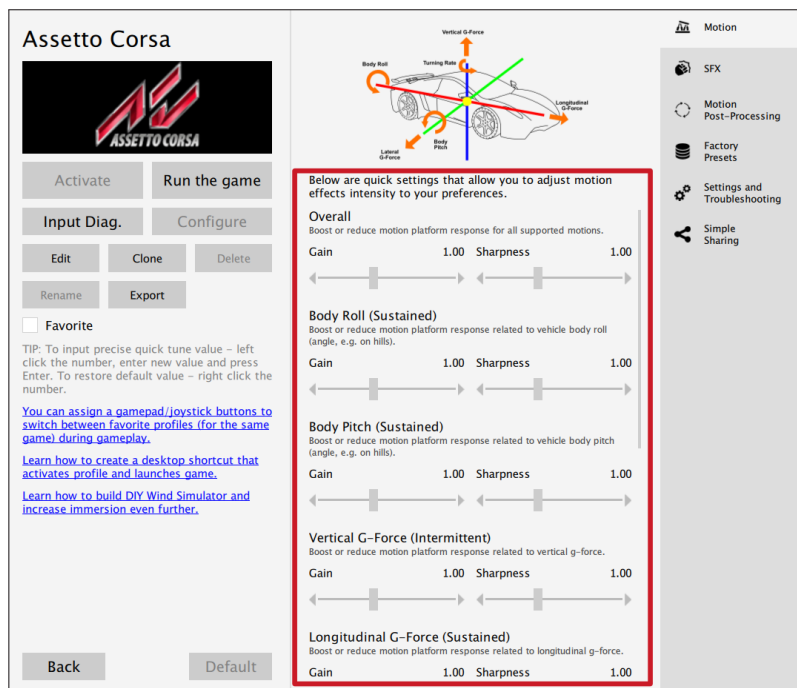

20. Activate profile by clicking the **Activate** button.

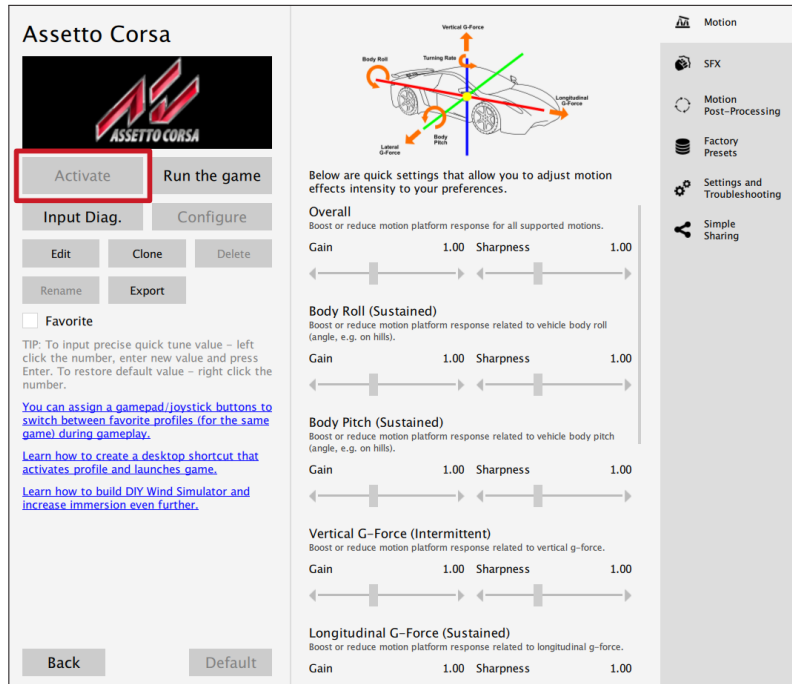

21. Launch on the game by clicking the **Run the game** button.

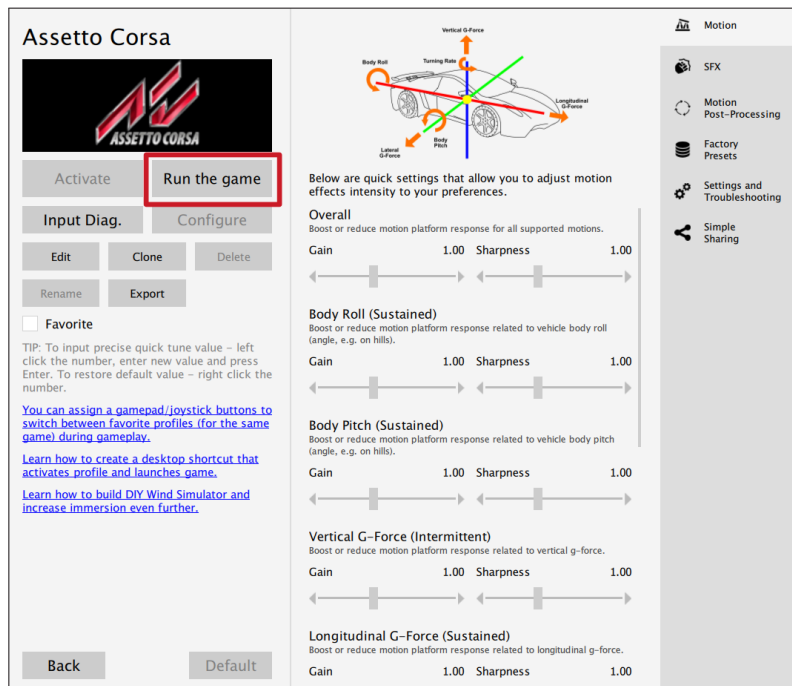

INFO

If you need the serial number to activate other software licences such as ForceSeatMI or ForceSeatDI, it can be found in the QubicManager. After connecting the QS-220-PL go to **Tools and Diagnostics → Devices**. Serial number is visible under the device name:

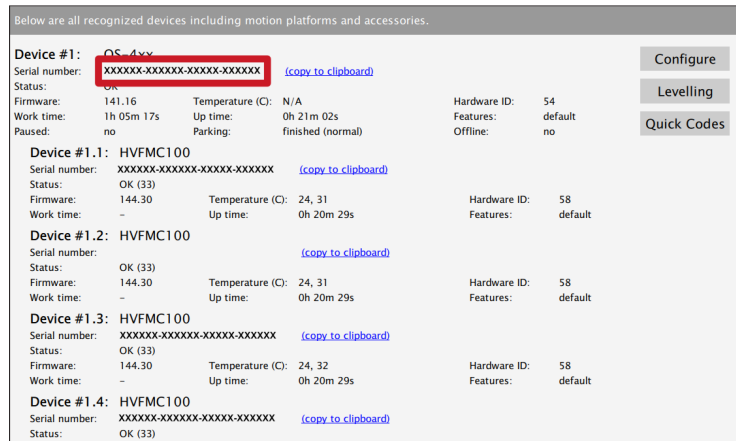

WARNING

The software is provided "as is", without warranty of any kind, express or implied, including but not limited to the warranties of merchantability, fitness for a particular purpose, and non-infringement. In no event shall the authors or copyright holders be liable for any claim, damages, or other liability, whether in an action of contract, tort or otherwise, arising from, out of, or in connection with the software or the use or other dealings in the software. The software sends anonymous usage data to the Motion Systems company. The data is used to improve the software and game profiles. The data is not used for advertising purposes.

4. MAINTENANCE AND CLEANING

To minimize the risk of abnormal heating that can result in system failure, keep the QS-220-PL uncovered, clean and dust-free. Cleaning of the unit shall be performed only with a soft, dry cloth. **DO NOT** use any chemicals, water and other liquids to clean the device.

At least once a month, check if Motion Lock Switch is working correctly – turn on the QS-220-PL (when no one is using the rig) and push the red button. If the machine turns off and does not react to any signal (turn on simulation or game to check it) then Motion Lock Switch works properly. If the machine reacts in any different way, stop using it and contact the technical support immediately.

To minimize the risk of QS-220-PL failure, check the condition of the linear actuator's rubber seals once a month, and lubricate them externally, if necessary, using a viscous lubricant spray with dispenser.

5. TROUBLESHOOTING

WARNING

DO NOT attempt to do any repairs by yourself. It is dangerous and voids the warranty! Repairs should be consulted with technical support and then performed by a qualified technician.

Before contacting technical support, try this:

- Check Action Center in QubicManager.
- Check power cables and connection between PC and QS-220-PL
- Check Motion Lock Switch position and its connection cables.
- Try different USB ports.
- If a problem occurred abruptly, it could be caused by thermal protection. Turn off QS-220-PL, disconnect it from power outlets and wait at least 15 minutes to let it cool down.
- In case of every unclear electrical issue like burnt fuses or strange behaviour, contact support.
- If abnormal work conditions, please immediately contact with the distributor/reseller for technical support.

6. ADVANCED APPLICATIONS

INFO

Examples shown in this section describes optional application of external safety and power cut-off devices. If you wish to expand the functionality of your motion system, read the whole section to have a good understanding of how to apply and what functionality to expect. Apply at your own discretion.

WARNING

Motion Lock input is not a SIL/PL (safety integrity level/performance level) rated and **DOES NOT** guarantee safety. If you wish to achieve specific SIL/PL ranking, consider introducing a power cut-off device that is controlled by an external safety relay and cuts off the power to all QS-SB2. Example application of the power cut-off contactor can be found in section 6.3.2 and 6.3.3.

INFO

When applying safety relay to the Motion Lock :

- Use input cables according to your safety relay manual.
- Use output cables according to your safety relay manual and cross section no less than 0,75 mm²

6.1. ADDING ADDITIONAL DEVICES TO THE MOTION LOCK CIRCUIT

If there is necessity to stop other devices, apart from the QS-220-PL , ML (Motion Lock) and additional customer devices can be controlled by safety relay outputs. In the example application, the E-STOP button is connected to the external safety relay. When the E-STOP is triggered, the safety relay will activate the Motion Lock function, which will stop motion of the platform and additional devices.

Example application of single-channel safety relay that controls ML and additional devices :

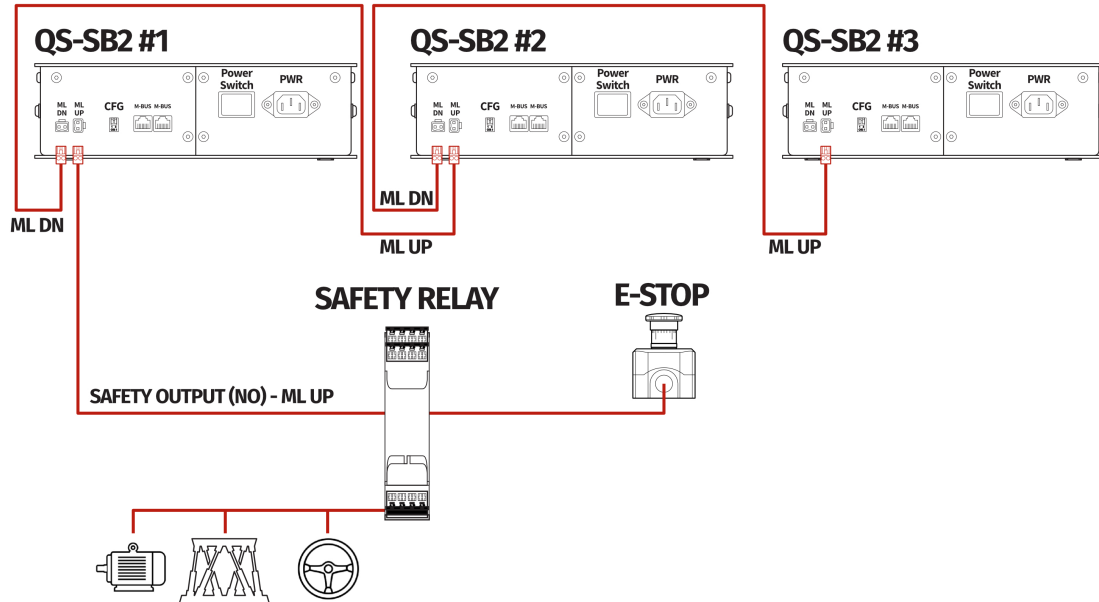

Example wiring diagram of application of single-channel safety relay:

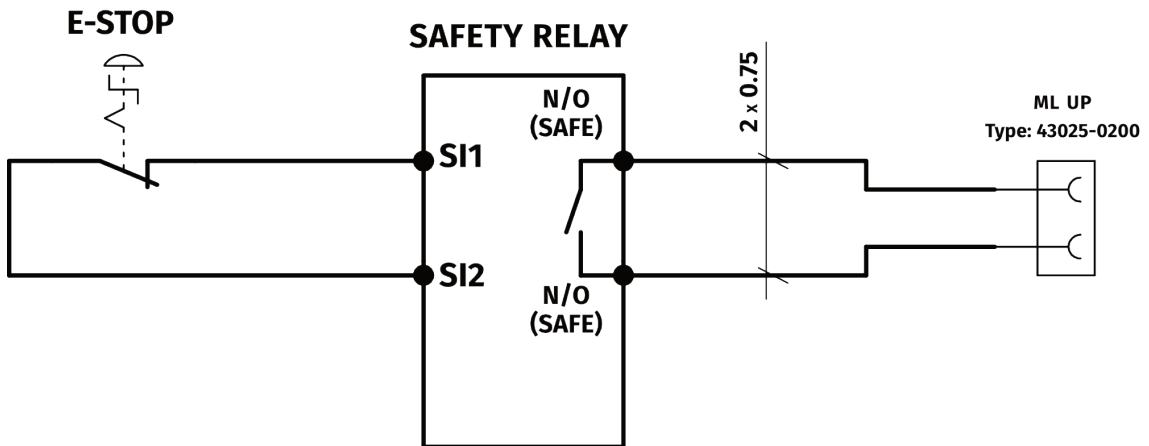

6.2. IMPLEMENTING THE WORKING ZONE PROTECTION

For protection against accidental hit from moving parts of the platform, safety gate with opening sensor* can be connected to safety relay input for activating ML function. When the gate is opened, the safety relay output activates the ML (Motion Lock) function and stops the motions of the platform.

Example application of safety gate opening sensor:

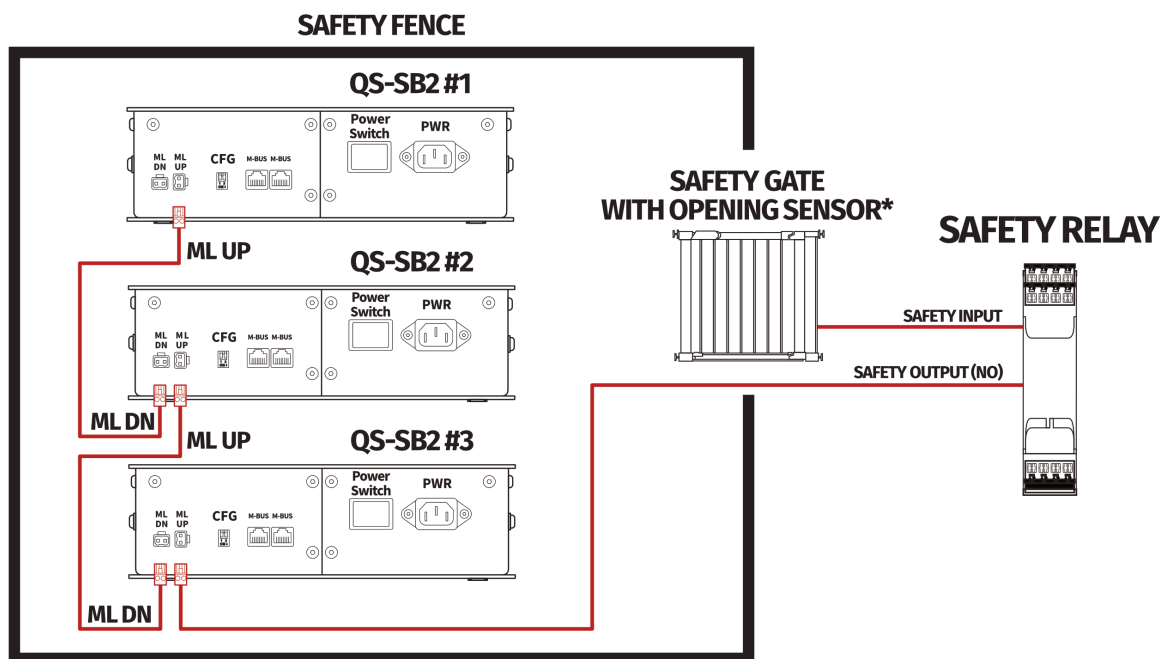

*Check your safety relay manual for list of applicable sensors

6.3. INCREASING SAFETY LEVEL

WARNING

Modifications of the safety system, involving application of the power line contactors, shall be performed only by a competent person. A competent person is a qualified and knowledgeable person, who because of their training, experience has the knowledge required to apply those changes. It is customer responsibility to commission modification of the safety system to a competent person, experienced with industrial wiring practices, which will be required to undertake the installation. Commissioning shall be undertaken by a trained electrical technician experienced in safety installations.

6.3.1 ASSEMBLING MOTION LOCK JUMPERS

To apply solutions which require to use power line contactors, Motion Lock connection cables in the QS-SB2 power cabinet needs to be replaced with jumpers, which are not provided with the system. Depending on the system revision, there are two types of Motion Lock connections. To prepare jumpers, you need to assemble recommended connectors as shown below, depending on what revision of the QS-SB2 power cabinet you own.

1. Jumper for QS-SB2 power cabinet with horizontal ML Slave/Master socket:

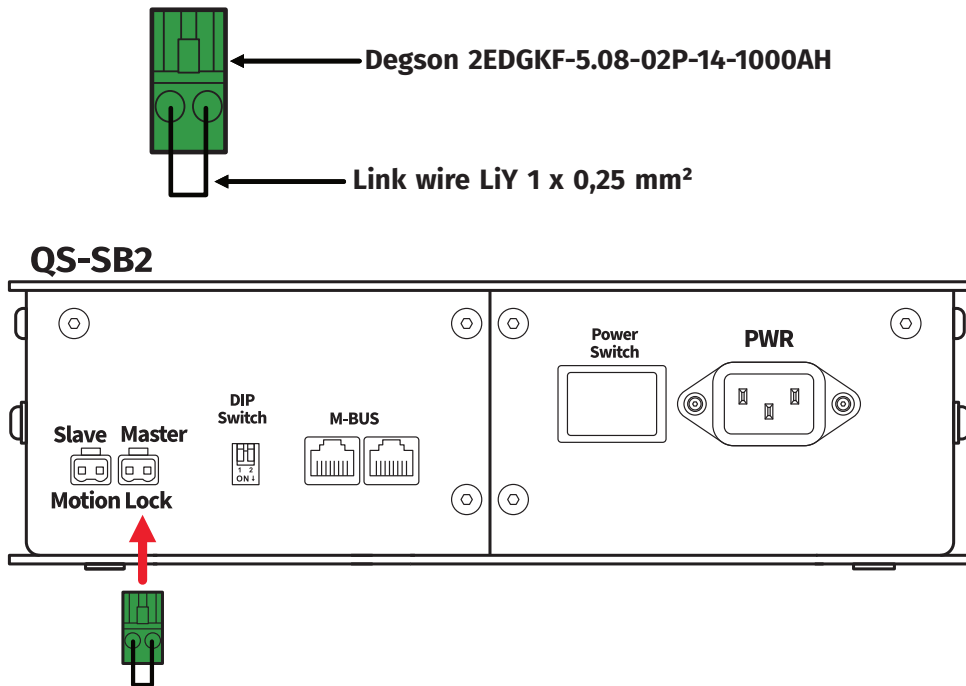

2. Jumper for QS-SB2 power cabinet with horizontal ML DN and vertical ML UP socket:

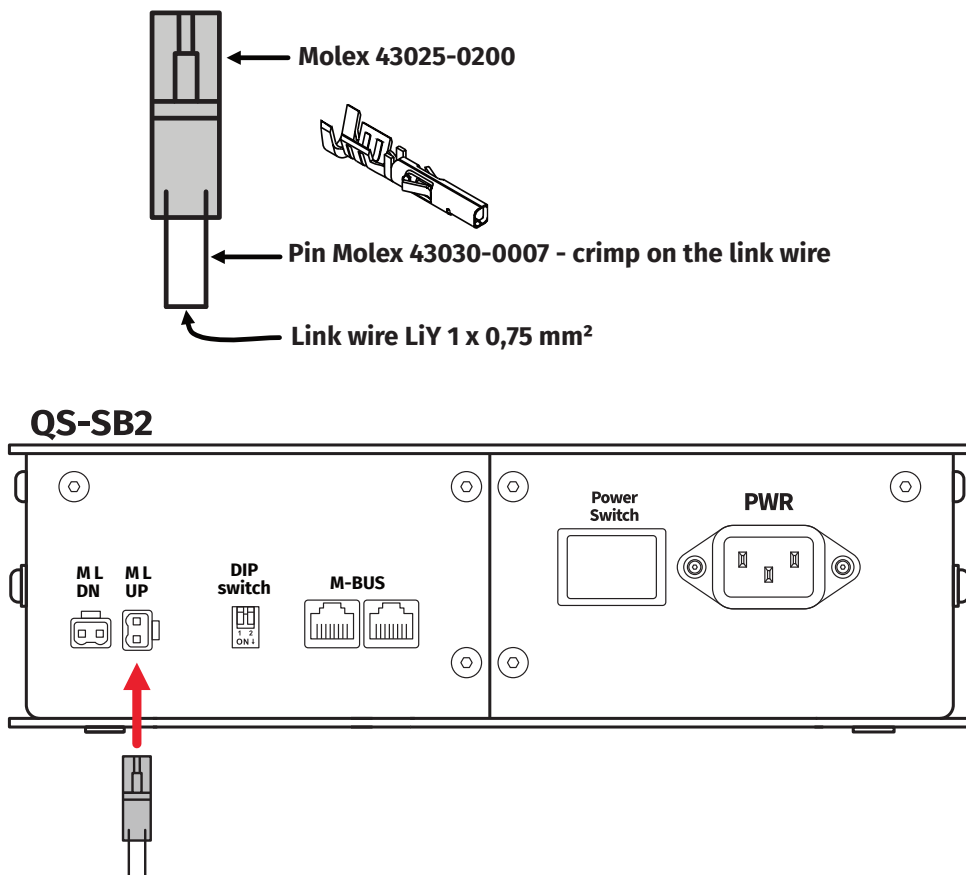

6.3.2 ADDING POWER-CUT CIRCUIT WITH E-STOP BUTTON

If specific SIL/PL rated level needs to be achieved, it might be necessary to install a power cut-off device. Two contactors connected in series and controlled by safety relay can be used to provide or cut-off power line to QS-SB2 power cabinets. When safety function on safety relay input is triggered, a safety relay will switch off the contactors, thus cutting-off the power to the platform. To apply this solution, Motion Lock Master or ML UP (depending on revision of the QS-SB2 power cabinet) connection cables needs to be replaced with prepared jumpers as described in section 6.3.1

INFO

To achieve required safety performance level it is necessary to perform safety risk assessment at customers site

Example application of power line contactors and E-STOP button:

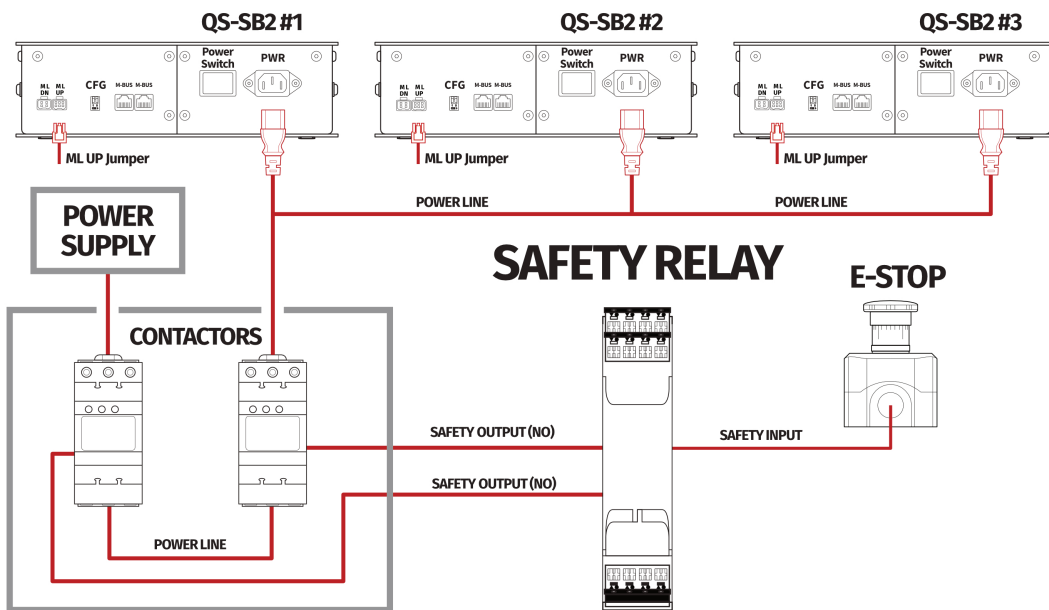

Example wiring diagram of application of power line contactors and E-STOP button:

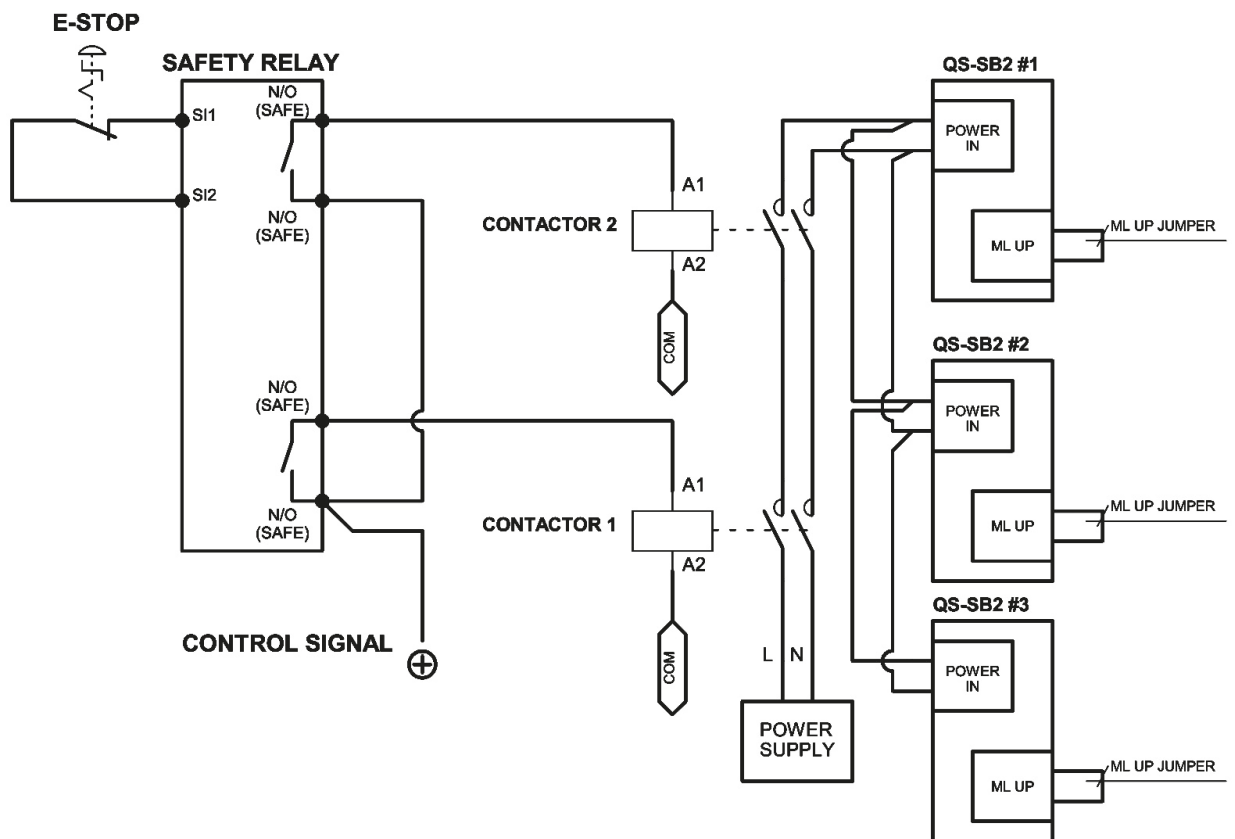

INFO

PE (protective grounding/earthing) connection is omitted for better transparency

6.3.3 IMPLEMENTING THE WORKING ZONE PROTECTION WITH POWER-CUT CIRCUIT

In example application contactors connected in series provide power line to the QS-SB2 power cabinets. When safety function on safety relay input is triggered, a safety relay will switch off the power contactors, thus cutting-off the power to the platform.

Example application of power line contactors with safety gate opening sensor:

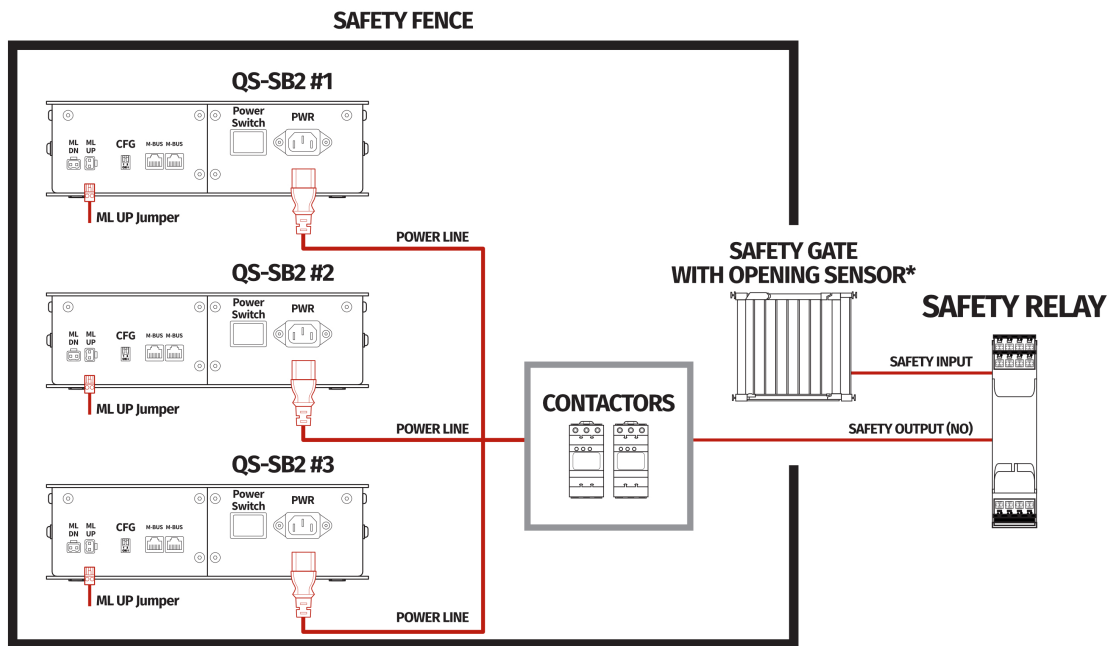

*Check your safety relay manual for list of applicable opening sensors

INFO

When applying safety relay and contactors to the power line remember to:

- Use control cables according to your safety relay manual
- Power line cables shall be chosen accordingly to power requirements of motion system. See power requirements of specific motion system.

7. CONFORMITY INFORMATION



The QS-220-PL meets the requirements of CE and relevant regulations of the EMC Directive 2014/30/EU and the RoHS Directive 2011/65/EU.

8. ENVIRONMENTAL IMPACT AND DISPOSAL

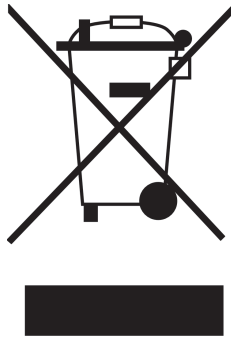

DO NOT dispose of this product with standard household waste, drop it off at a collection point for the disposal of Waste Electrical and Electronic Equipment for recycling.

QS-220-PL is an advanced device and if stored or disposed of incorrectly, it could harm the environment or/and other people. Please contact your local authorities for information at the collection point nearest you.

9. LIABILITY DISCLAIMER

If permitted under applicable law, Motion Systems and its subsidiaries disclaim all liability for any damages caused by one or more of the following:

- The product has been modified, opened, or altered.
- Failure to comply with a User Manual.
- Inappropriate or abusive use, negligence, an accident (an impact, for example).
- Normal wear.

INFO

If permitted under applicable law, Motion Systems and its subsidiaries disclaim all liability for any damages unrelated to the material or manufacturing defect with respect to the product (including, but not limited to, any damages caused directly or indirectly by any software, or by combining the QS-220-PL with any unsuitable element or not other elements not supplied or not approved by Motion Systems for this product).

10. WARRANTY

Motion Systems warrants to the consumer that this product shall be free from defects in materials and workmanship, for a warranty period which corresponds to the time limit to bring an action for concerning this product.

For commercial customers, there is a one (1) year limited warranty, starting on the original date of purchase.

Within the warranty period, the product will be repaired or replaced free of charge, excluding shipping charges.

This warranty shall not apply:

- If the product has been modified, opened, altered, or has suffered damage as a result of inappropriate or abusive use, negligence, an accident, normal wear, or any other cause unrelated to a material or manufacturing defect (including, but not limited to, combining the QS-220-PL with any unsuitable element, including in particular power supplies, chargers, or any other elements not supplied or approved by Motion Systems for this product).
- In the event of failure to comply with the instructions provided by technical support.
- To software, said software being subject to a specific warranty.
- To accessories (cables, cases, for example).
- If the product was sold at public auction or if the product has suffered damage as a result of force majeure: flood, fire, earthquake, storm.

This warranty is non-transferable. No new warranty period commences if the product is repaired or replaced. Your statutory rights towards the seller are not affected or restricted by this warranty. Motion Systems, and their partners are not liable for any indirect, incidental, or punitive damages from use of this product. In case of malfunction during the warranty period immediately contact technical support.

11. COPYRIGHT

Qubic System is a trademark of Motion Systems. All rights reserved.

All the contents in this user manual are the intellectual property of Motion Systems. No part of this manual, including the products and software described in it, shall be modified or translated into any language without the prior written permission of Motion Systems. Specifications and information in this manual are subject to change at any time without obligation to notify any person of such revision or changes. Illustrations are not binding.

INFO

Trademark Notice - All brand names, icons, and trademarks that appeared in this manual are the sole property of their respective holders.

12. MANUFACTURER INFORMATION

Motion Systems

Miedziana 7 Street
55-003 Nadolice Wielkie
Poland



INFO

In support queries please contact your reseller.



QUBICSYSTEM